

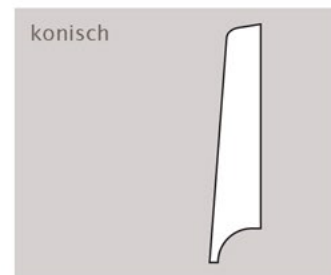

## Dimensionen, Profile und Schrauben

Dimensionen	Profil-Ausführungen			
	kantig	abgeschrägt	abgerundet	konisch
25/10 mm	●	●	●	
25/15 mm	●	●	●	
30/11 mm	●	●	●	
30/12/8 mm				●
30/15 mm	●	●	●	
30/15/10 mm				●
40/11 mm	●	●	●	
40/12/8 mm				●
40/15 mm	●	●	●	
40/15/10 mm				●
50/11 mm	●	●	●	
50/12/8 mm				●
50/15 mm	●	●	●	
50/15/10 mm				●
60/11 mm	●	●	●	
60/12/8 mm				●
60/15 mm	●	●	●	
60/15/10 mm				●
70/11 mm	●	●	●	
70/12/8 mm				●
70/15 mm	●	●	●	
70/15/10 mm				●
80/11 mm	●	●	●	
80/12/8 mm				●
80/15 mm	●	●	●	
80/15/10 mm				●
90/11 mm	●	●	●	
90/12/8 mm				●
90/15 mm	●	●	●	
90/15/10 mm				●
100/11 mm	●	●	●	
100/12/8 mm				●
100/15 mm	●	●	●	
100/15/10 mm				●

Unsere eigene Produktion ermöglicht jede Dimension.

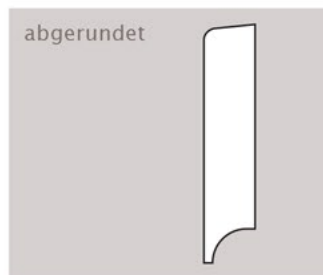
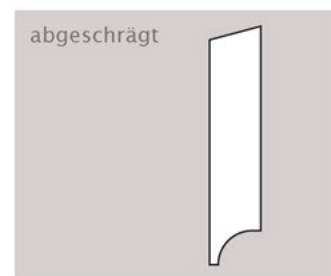
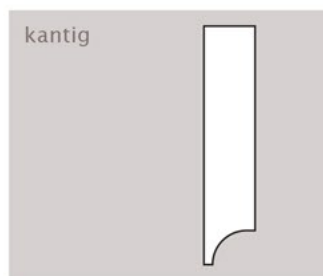

### Profil-Ausführungen

Neben den abgerundeten, abgeschrägten, kantigen und konischen Profilen sind auch Ausführungen nach Wunsch und Skizze möglich.

### Oberflächenbehandlungen

- roh
- oxidativ geölt (natur, weiss, extra weiss usw.)
- UV-geölt
- natur lackiert
- extra matt lackiert
- RAL-/NCS-Farbtone
- eingefärbt nach Muster

# Dimensionen und Profile

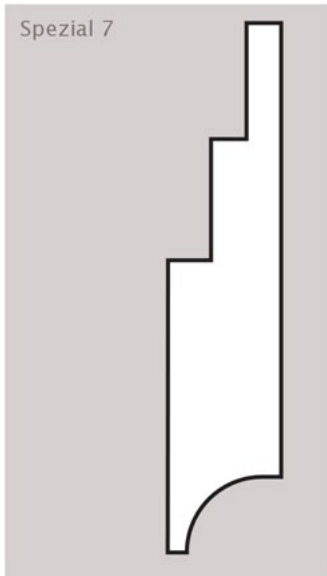
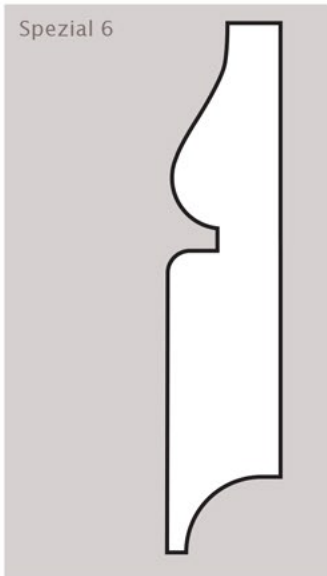
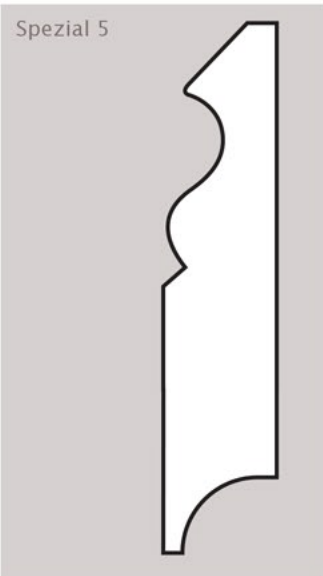
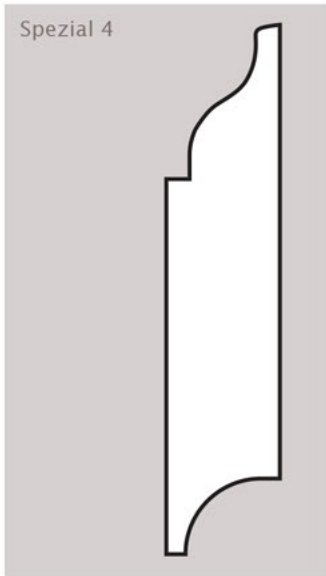
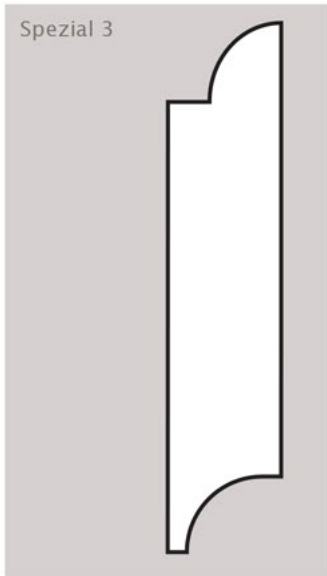
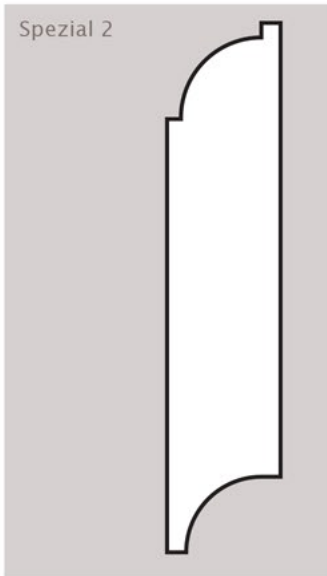
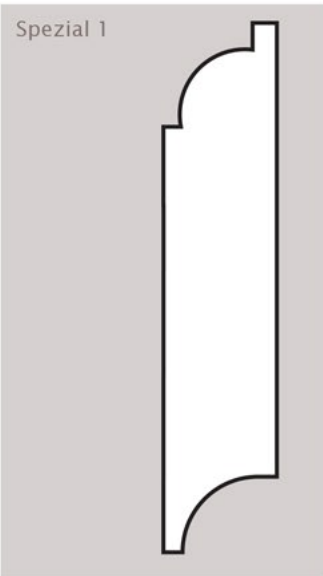
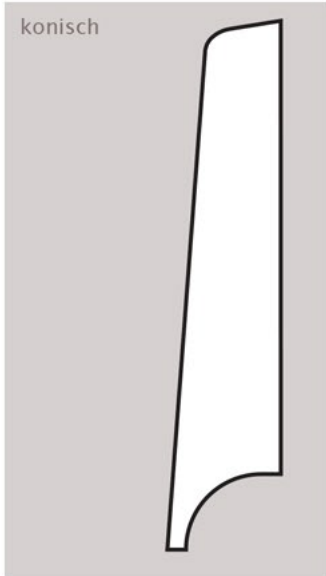
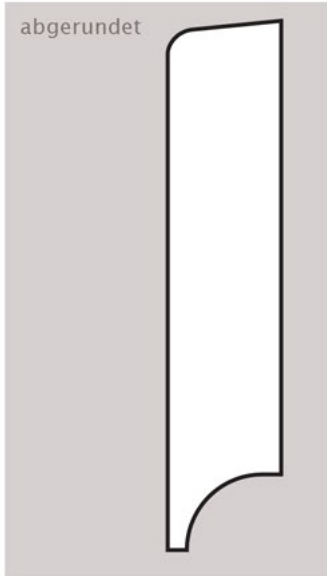
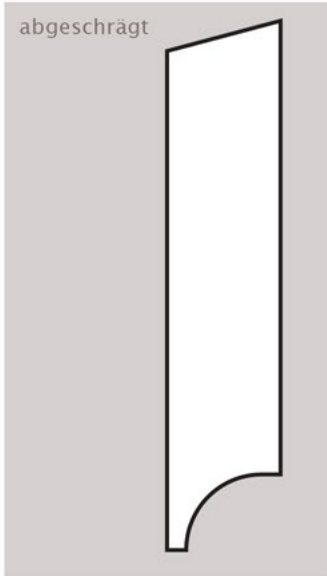
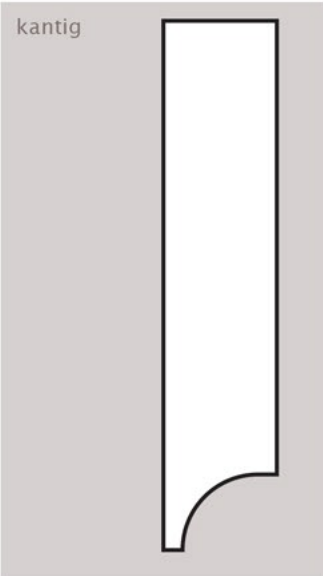

Praktisch alle Profile sind aufgrund von Skizzen oder Muster realisierbar.

# Dimensionen und Profile 25 mm

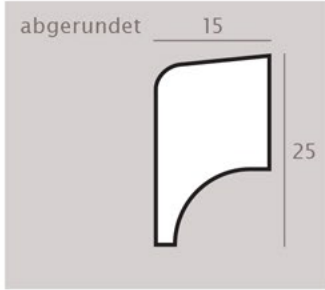
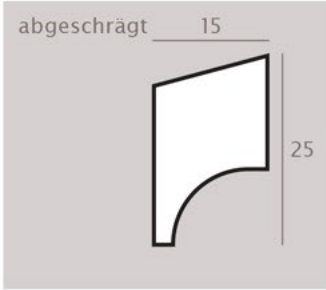
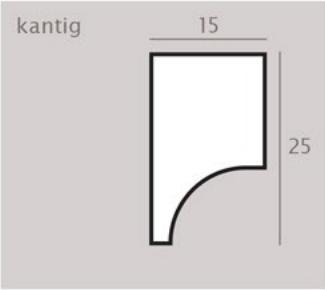
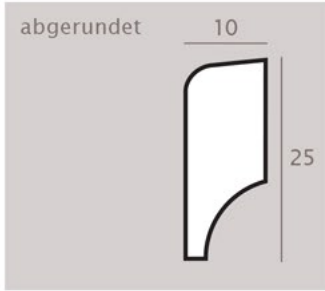
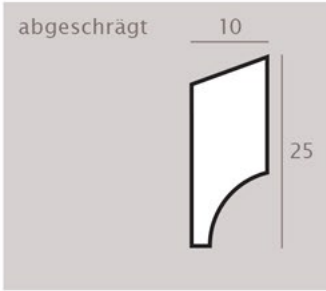
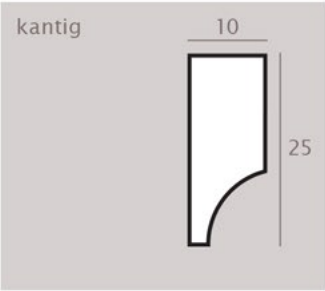

# Dimensionen und Profile 30 mm

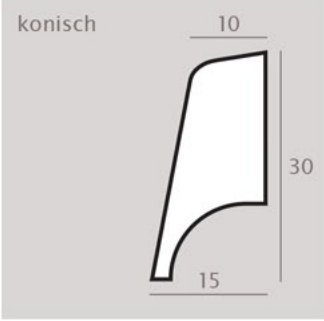
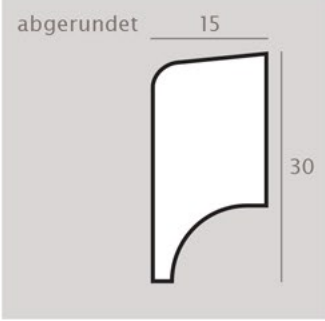
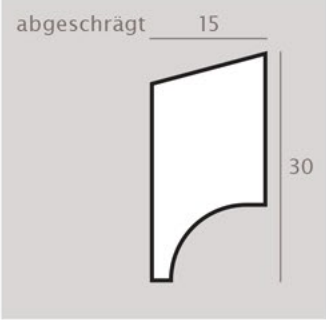
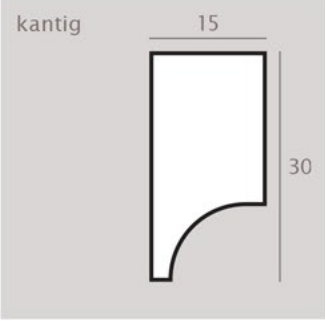
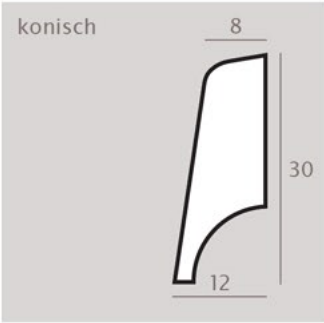
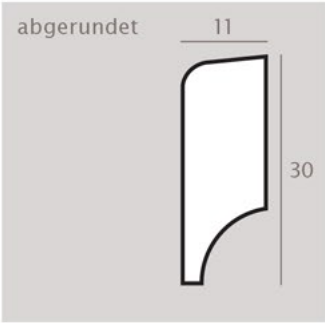
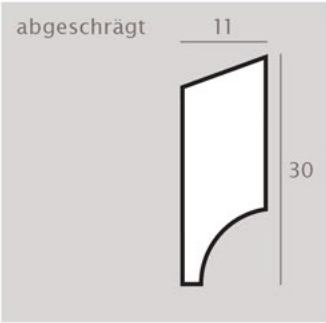
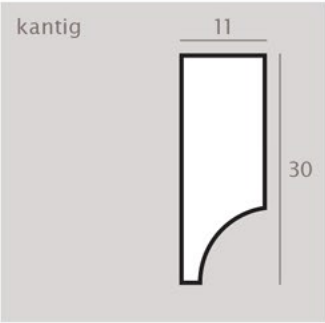

# Dimensionen und Profile 40 mm

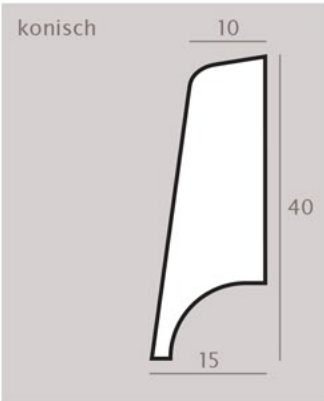
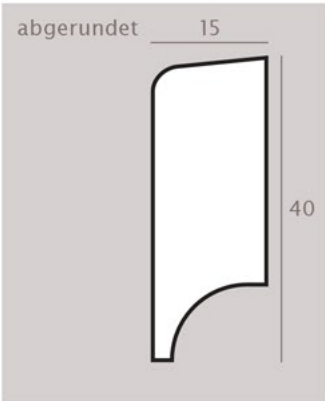
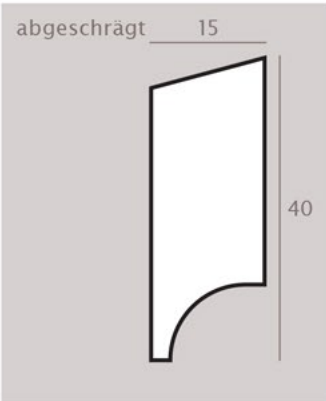
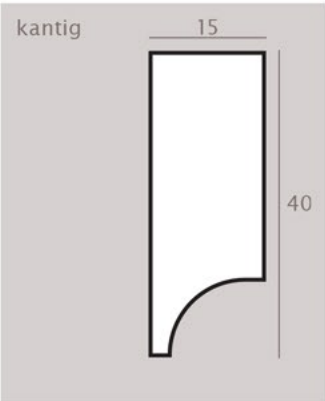
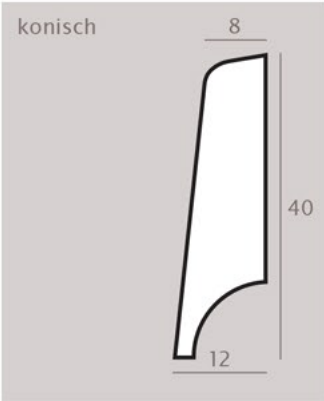
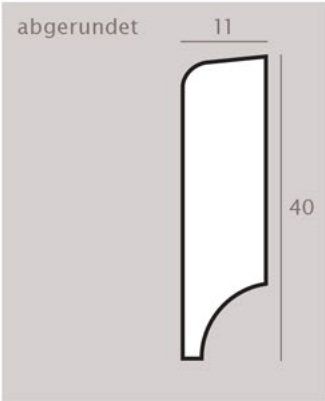
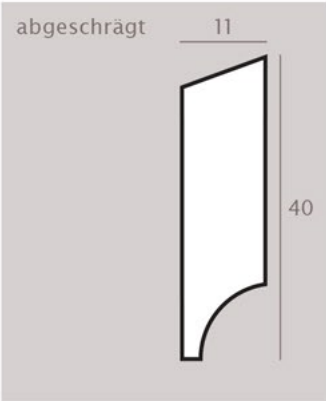
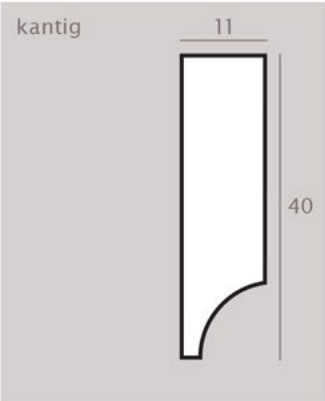

# Dimensionen und Profile 50 mm

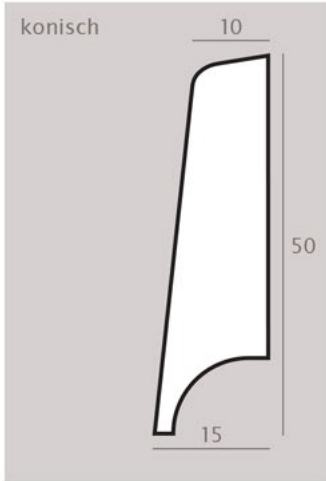
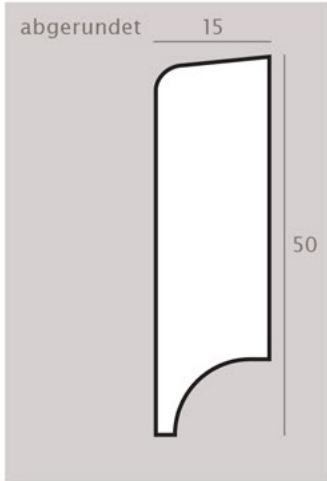
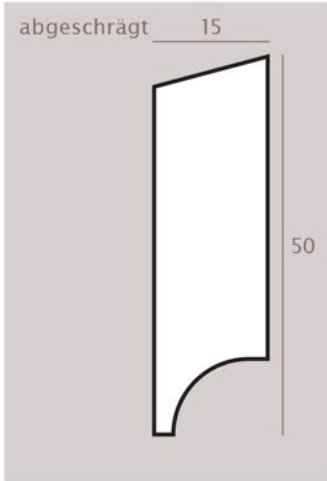
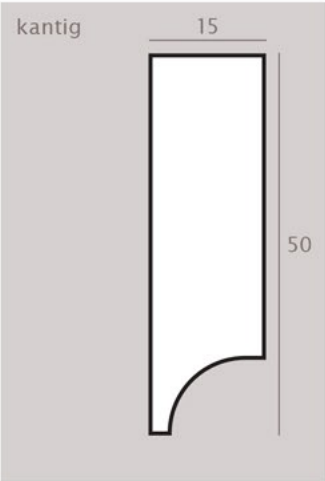
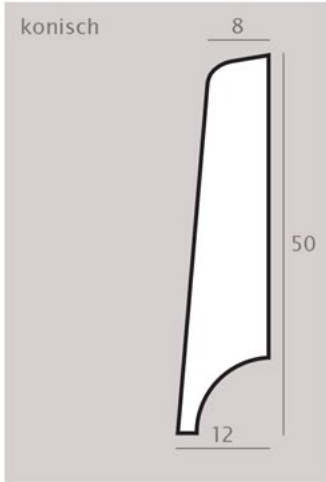
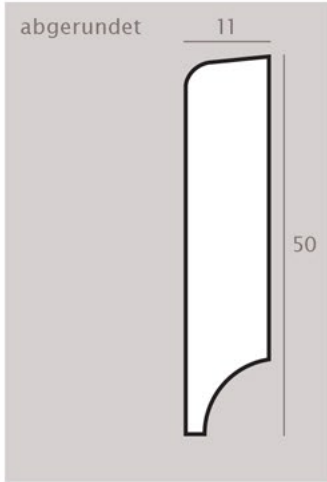
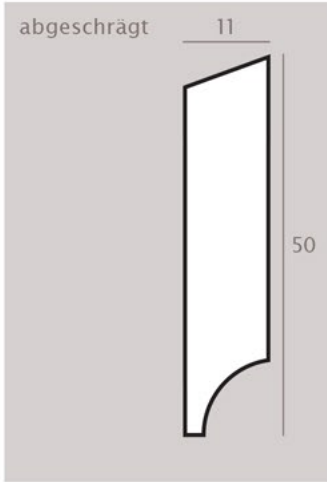
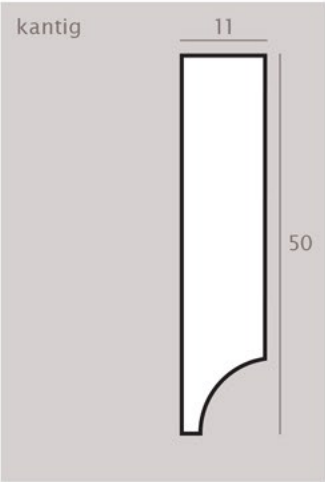

# Dimensionen und Profile 60 mm

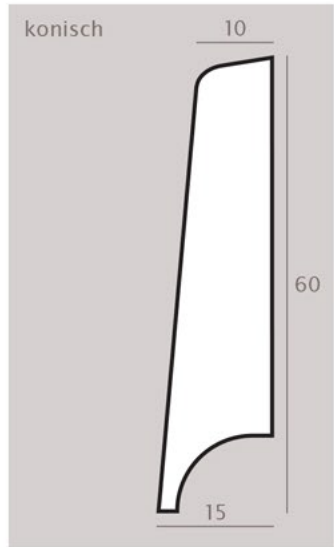
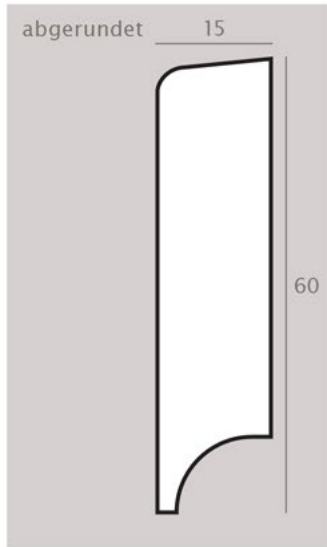
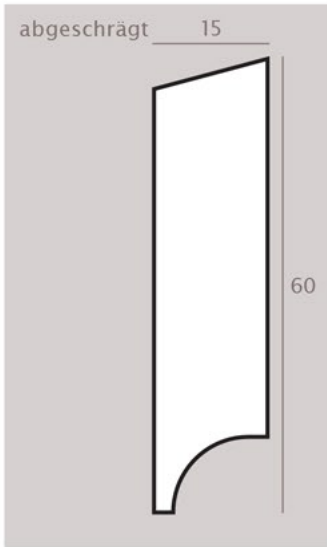
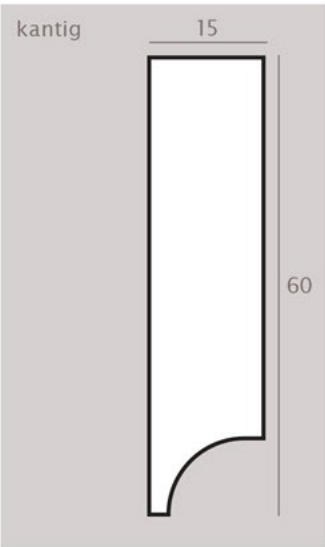
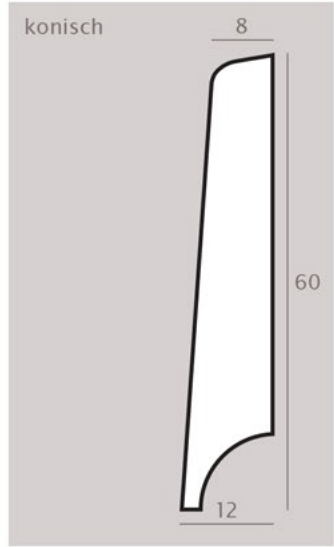
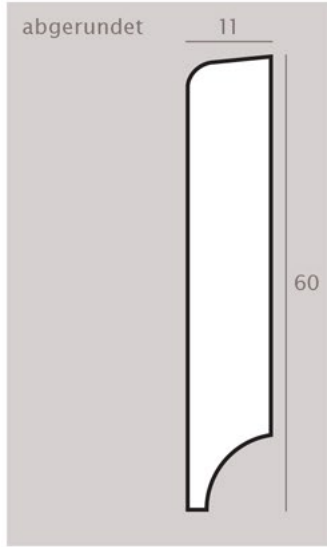
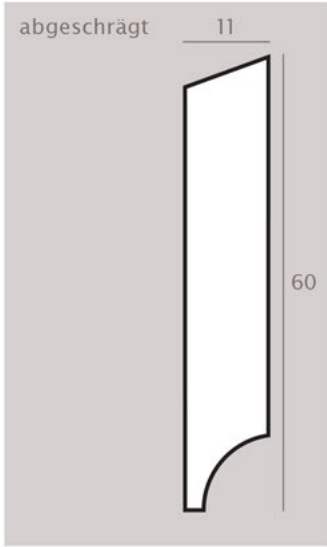
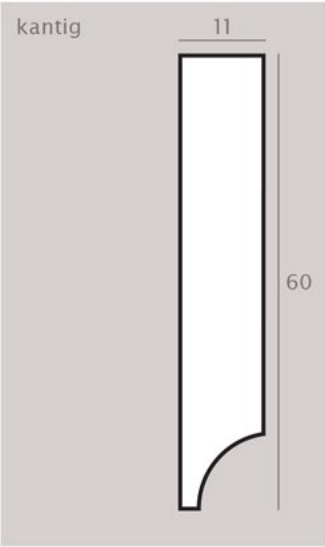

# Dimensionen und Profile 70 mm

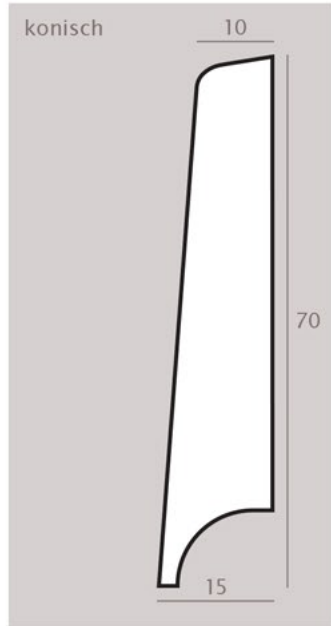
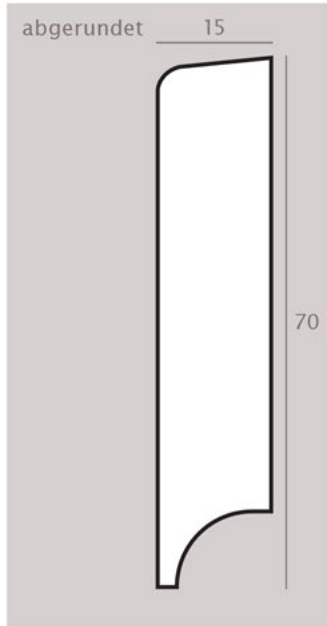
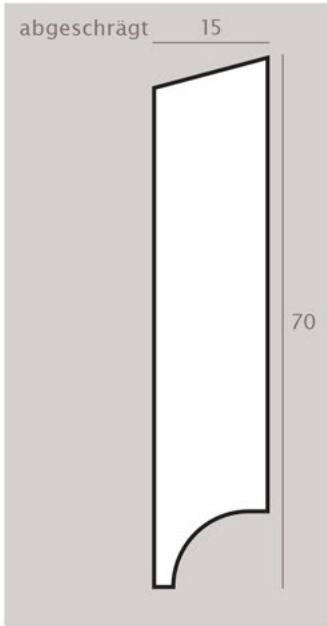
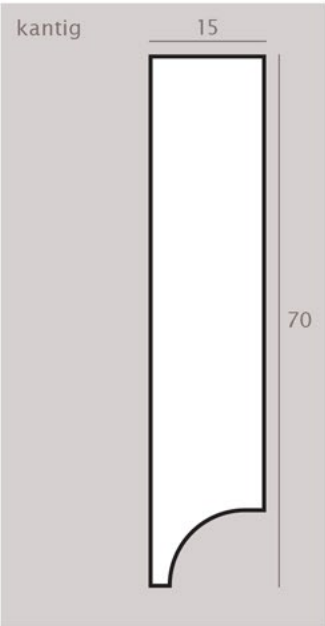
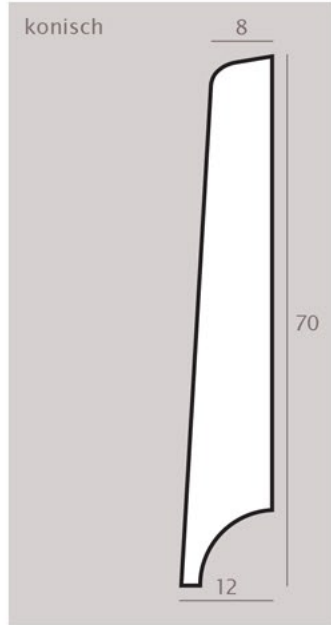
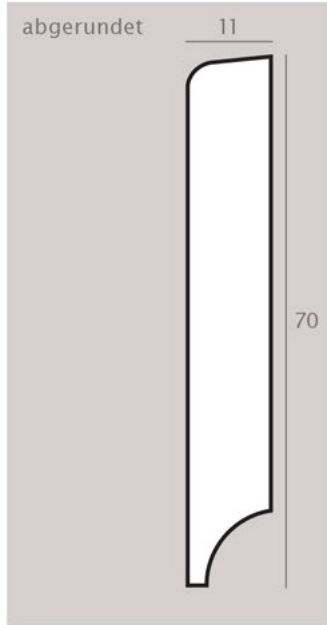
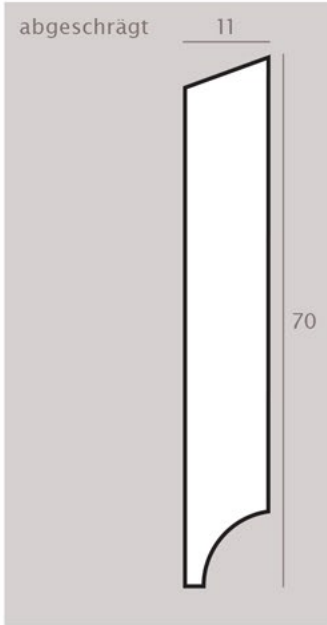
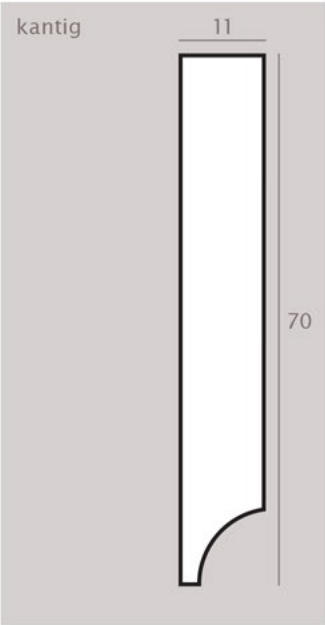



# Dimensionen und Profile 80 mm

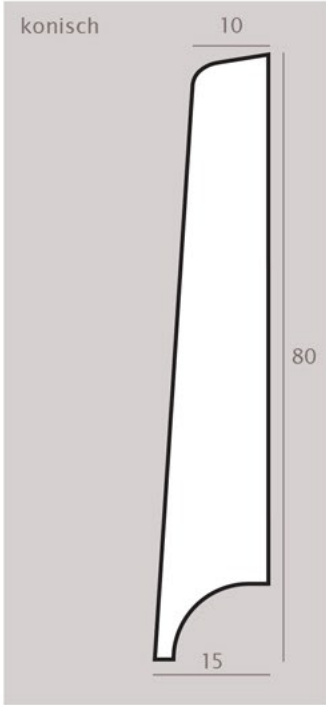
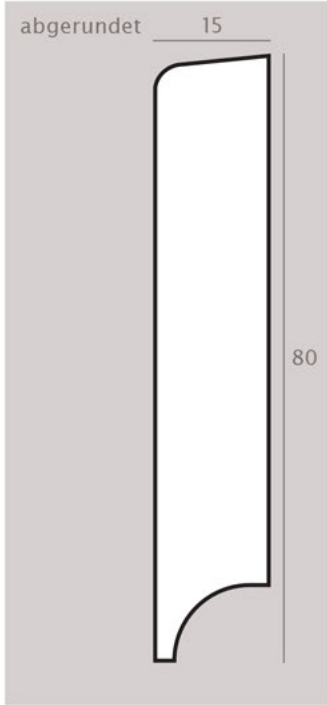
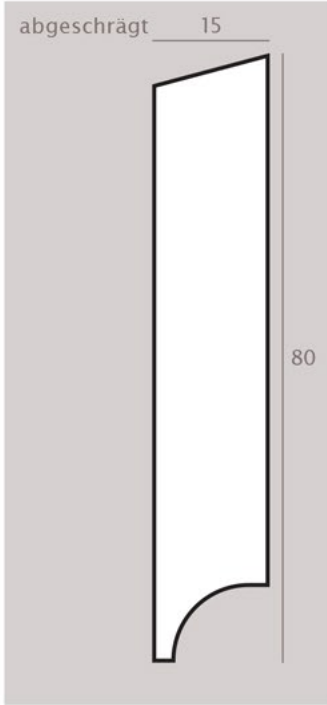
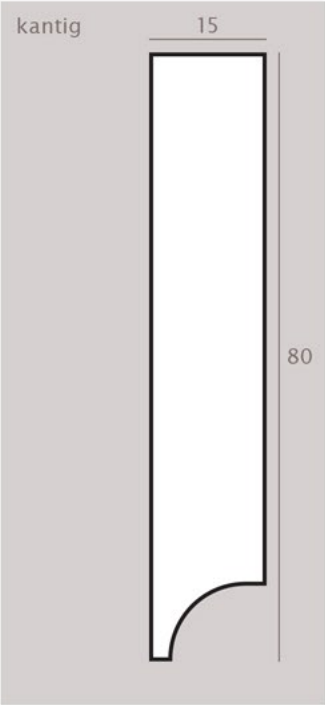
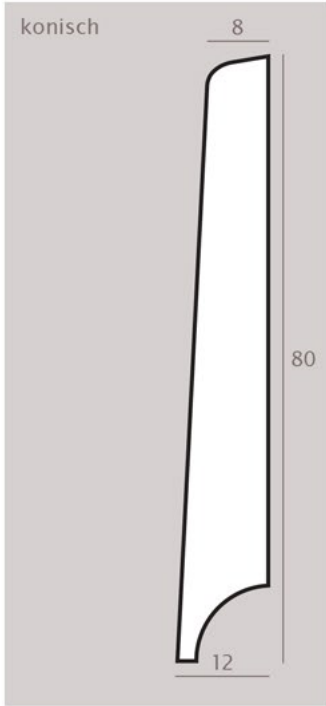
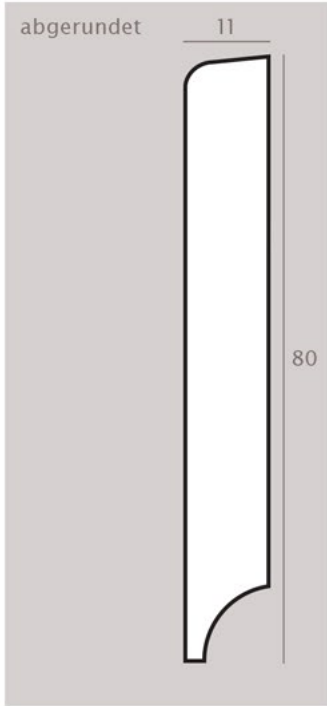
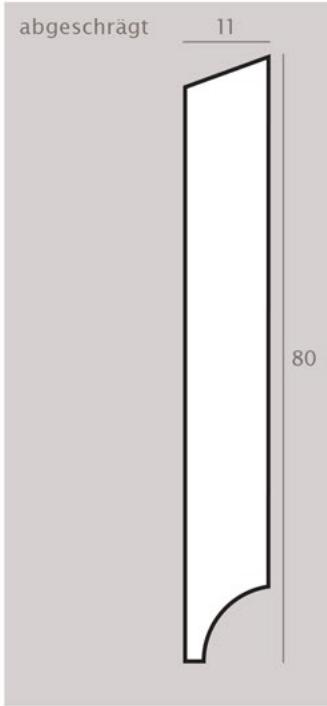
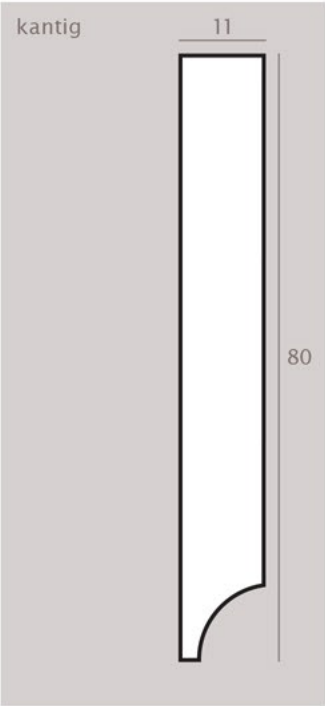

# Dimensionen und Profile 90 mm

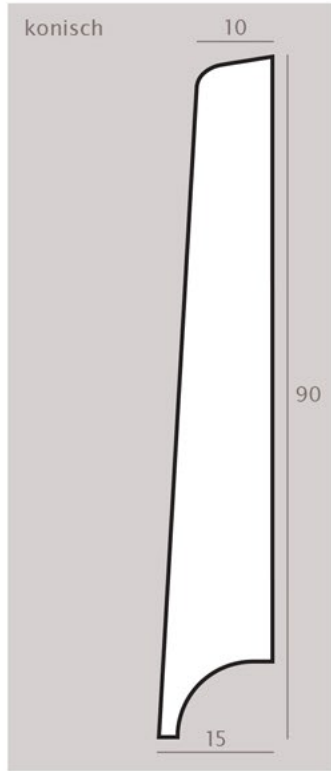
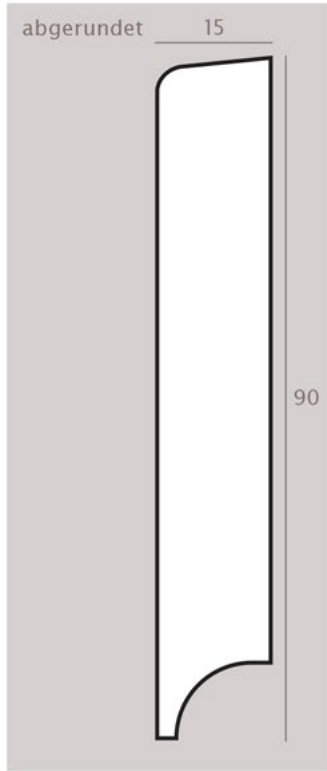
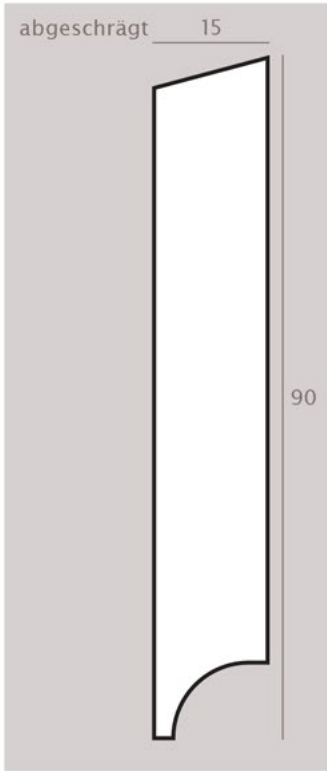
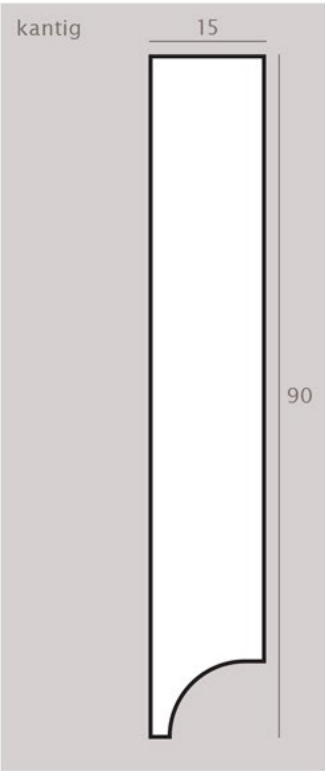
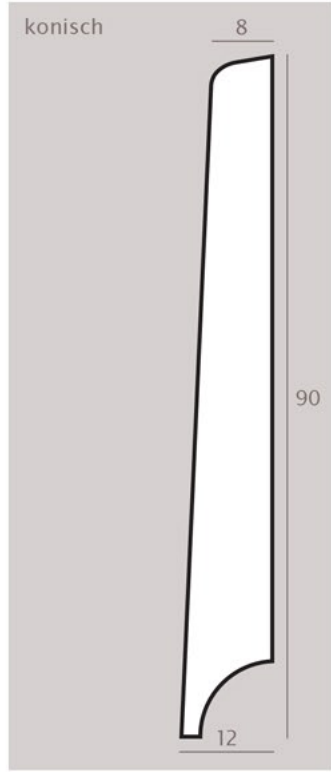
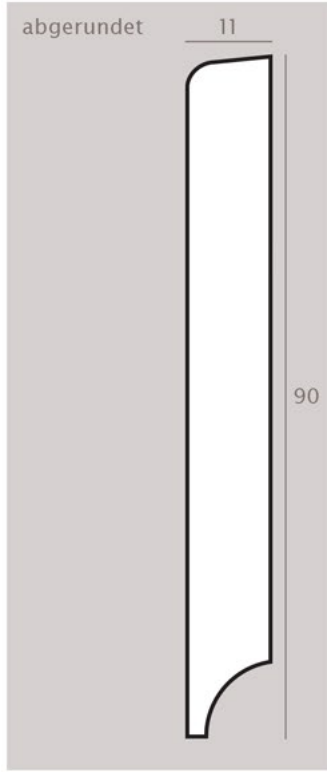
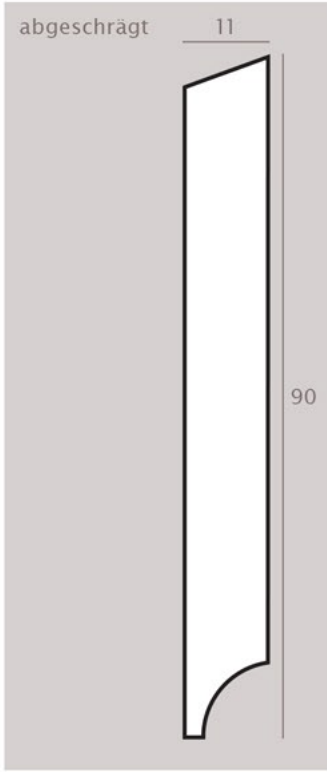
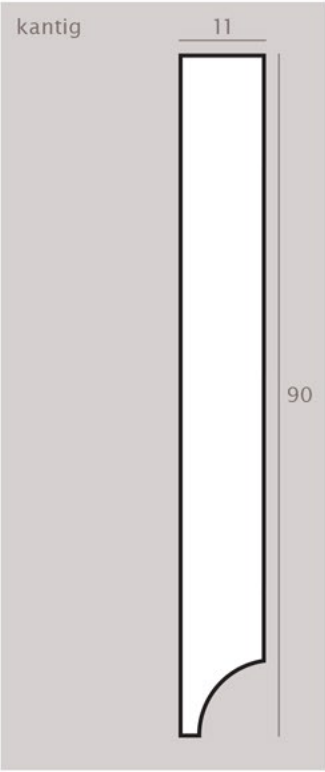

# Dimensionen und Profile 100 mm

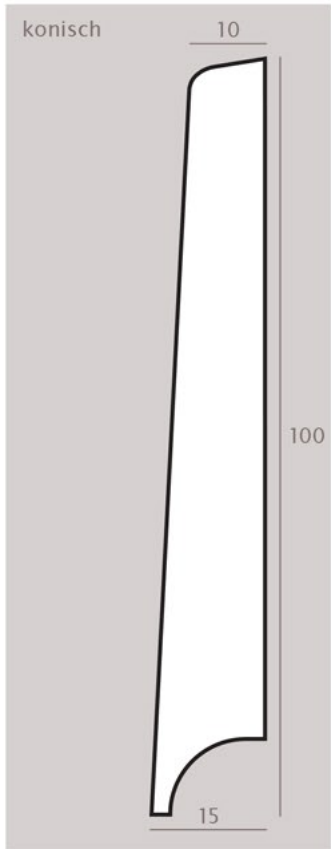
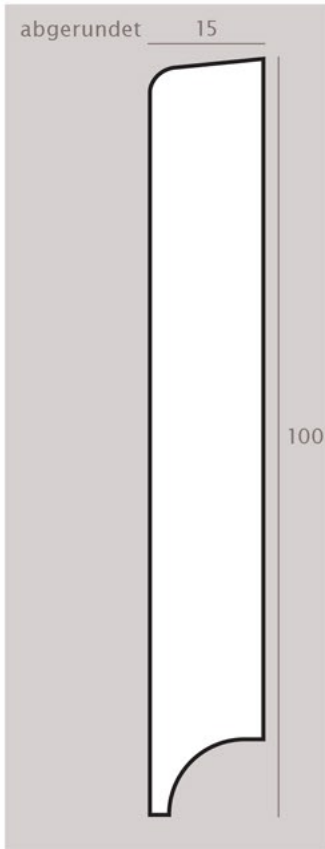
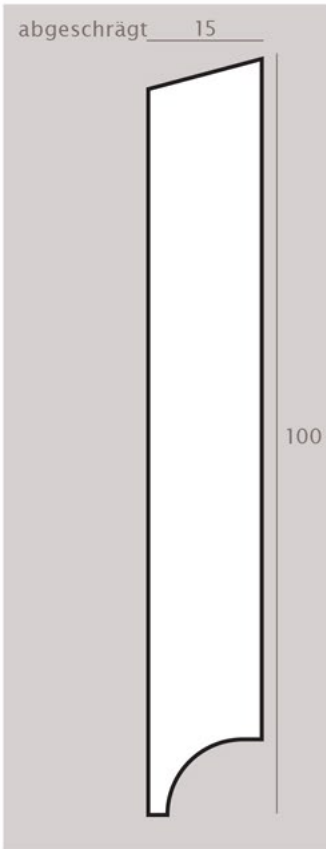
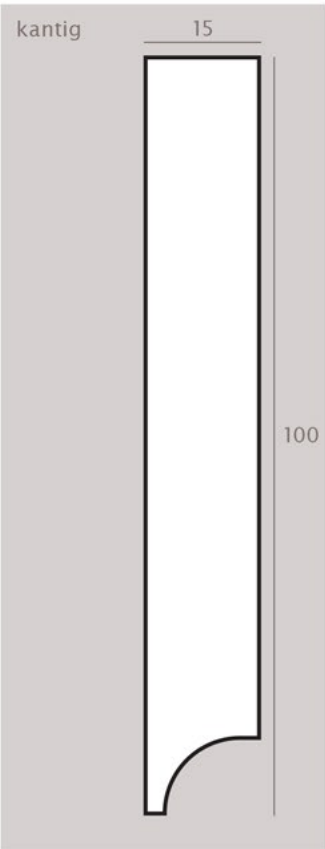
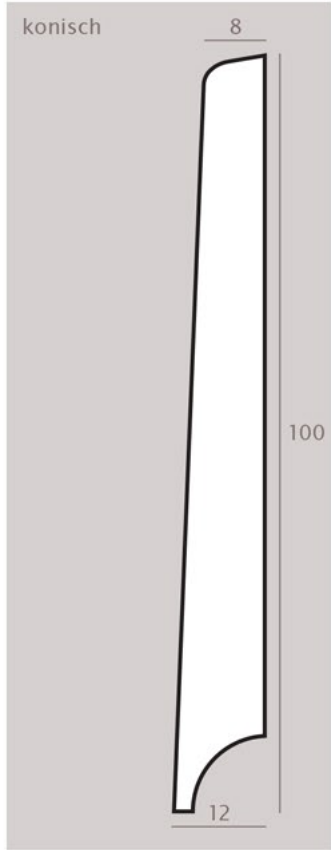
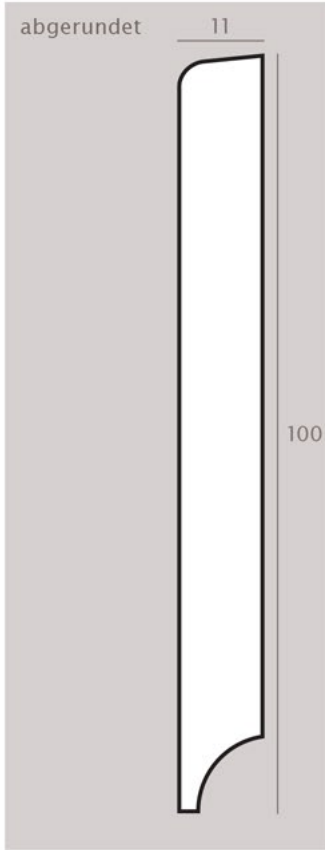
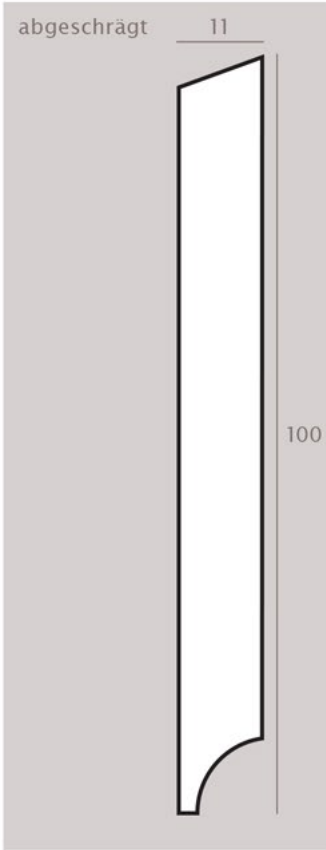
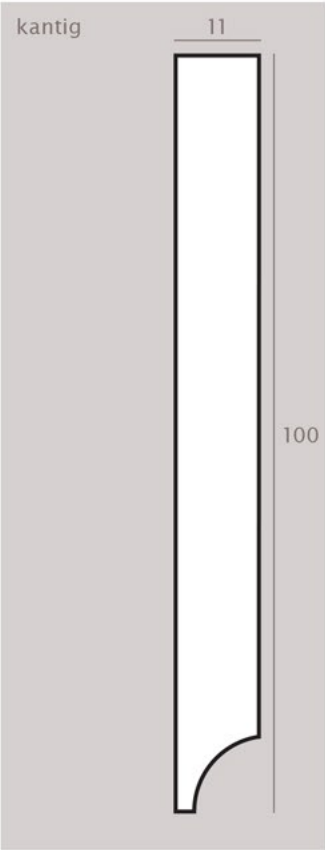

# Spezielle Profile

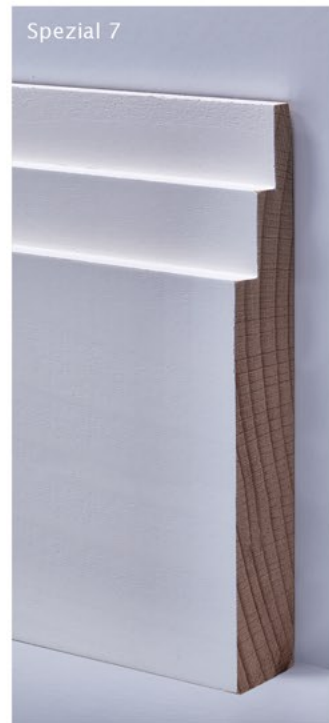

# Schrauben

Linsenkopf  
Schlitzschraube\* vernickelt



für diverse  
Holz-Sockelleisten  
usw.

Linsenkopf  
Kreuzschlitzschraube  
vernickelt



für diverse  
Holz-Sockelleisten  
usw.

Flachkopf  
Schlitzschraube\* vernickelt



für diverse  
Holz-Sockelleisten  
usw.

Linsenkopf  
Schlitzschraube\* INOX A2



für Alu-Sockelleisten  
usw.

Flachkopf  
Schlitzschraube\* INOX A2



für Alu-Sockelleisten  
usw.

Linsenkopf  
Schlitzschraube\* weiss



für weisse Holz- und  
Alu-Sockelleisten

Flachkopf  
Schlitzschraube\* weiss



für weisse Holz- und  
Alu-Sockelleisten

Linsenkopf  
Kreuzschlitzschraube weiss



für weisse Holz- und  
Alu-Sockelleisten

Linsenkopf  
Schlitzschraube\* brüniert



für braune / eingefärbte  
Holz-Sockelleisten,  
z.B. Räuchereiche

Linsenkopf  
Schlitzschraube\* messing



für diverse Holz-Sockel-  
leisten, z.B. Eiche

Linsenkopf  
Kreuzschlitzschraube  
messing



für diverse Holz-Sockel-  
leisten, z.B. Eiche

Linsenkopf  
Schlitzschraube\* lichtgrau



für lichtgraue Holz- und  
Alu-Sockelleisten

Linsenkopf  
Schlitzschraube\* verzinkt,  
schwarz



für schwarze Holz- und  
Alu-Sockelleisten

Linsenkopf

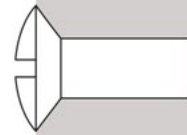

Flachkopf

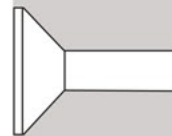

Weitere Schrauben  
auf Anfrage